



Measure Guide

Machine Make: _____ Model: _____

Platform

Exterior Height: _____ Inches
 Exterior Width: _____ Inches
 Exterior Length: _____ Inches
 Interior Height*: _____ Inches

Extension

Extension Length: _____ Inches
 Extension Interior Width _____ Inches

Entrance

Select one entry location:

- Entry 1 (Left)
- Entry 1 (Center) *Standard*
- Entry 1 (Right)
- Entry 2 (Center)

Scissor Lift

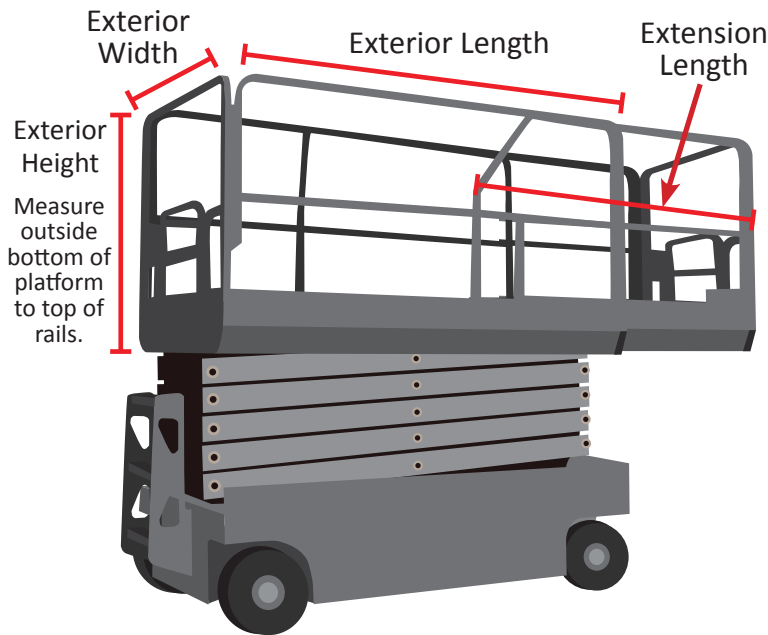

*Interior Height:
Please measure inside floor to top of rails.

Extension Interior Width:
Please measure interior width between bars on extension.

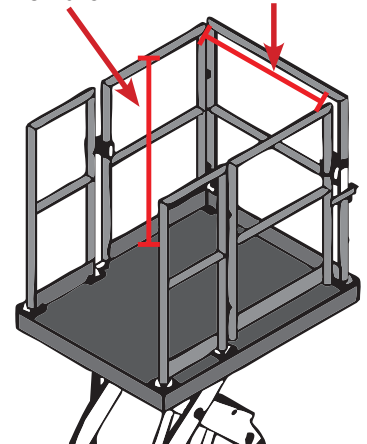

Entry Position Options

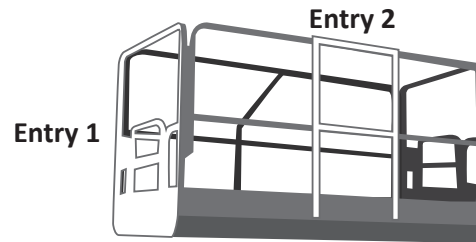
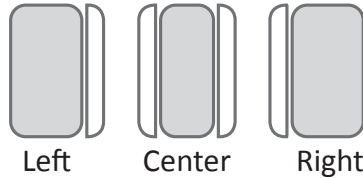

Customer Information

Date: _____ PO Number: _____

Company: _____

Name: _____

How to Order: Call: 1-888-SOCK-911
 Email: info@TireSocks.com Fax: 303-942-9399

Branch #: _____ Phone: _____

Email Address: _____



Measure Guide

Machine Make: _____ Model: _____

Boom Lift

Platform	
Height:	_____ Inches
Width:	_____ Inches
Length:	_____ Inches
Extension:	<input checked="" type="checkbox"/> None

Entrance	
Select one entry location:	
<input type="checkbox"/>	Entry 1 (Center)
<input type="checkbox"/>	Entry 2 (Center) <i>Standard</i>
<input type="checkbox"/>	Entry 3 (Center)

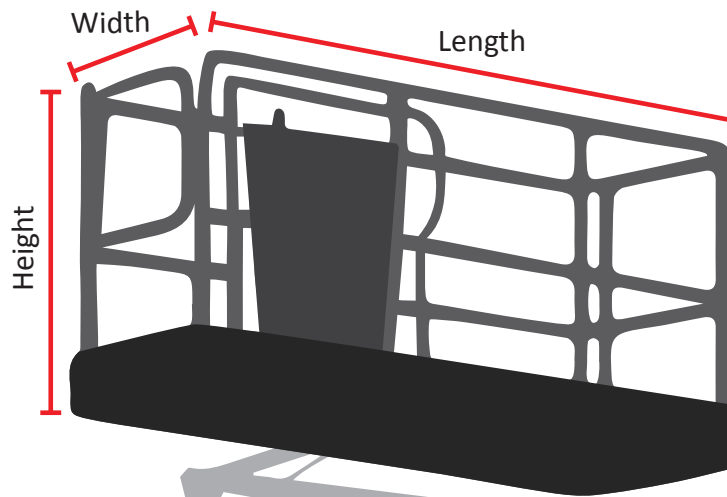

Entry Position Options

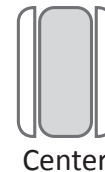

All boom lift entry positions are centered

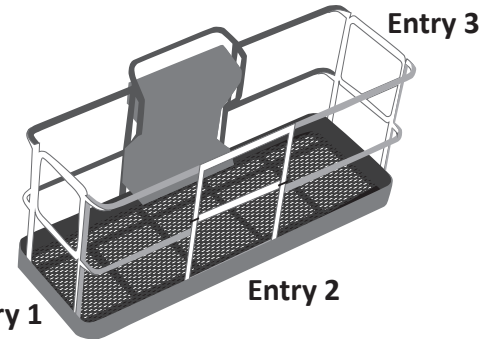
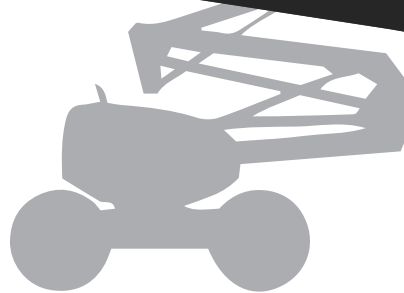

Customer Information

Date: _____ PO Number: _____

Company: _____

Name: _____

How to Order: Call: 1-888-SOCK-911
Email: info@TireSocks.com Fax: 303-942-9399

Branch #: _____ Phone: _____

Email Address: _____